

Construção de Material Didático

Matemática com a folha de papel

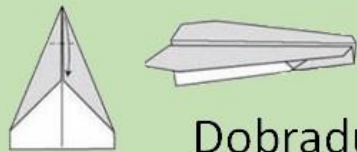
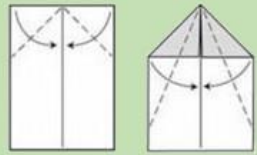

Carga Horária: 40 horas

Público:
Professores e Graduandos
de Licenciatura em Matemática

Dobraduras Planificações

Tangram Circulo Trigonométrico

Construções Geométricas



AULA 17

Prof. Dr. Osvaldo dos Santos Barros
www.osvaldosb.com

Gradeamento do Quadrado

A partir de uma folha de papel, construa um quadrado.

1

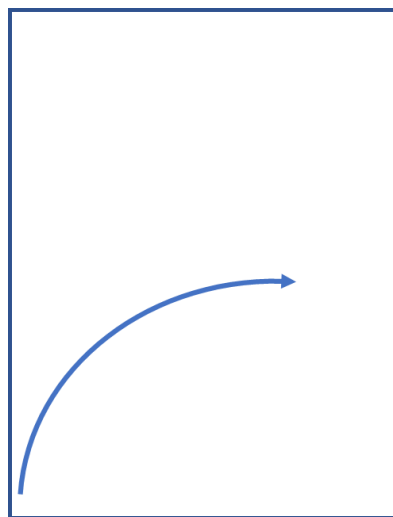

O lado menor se sobrepõe ao lado maior

2

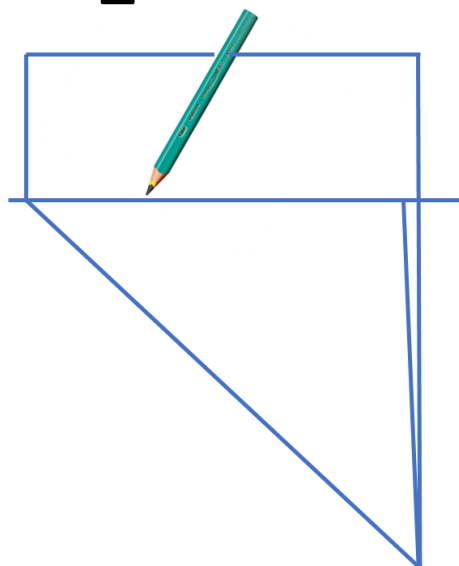

Usar um lápis para marcar onde será cortado

3

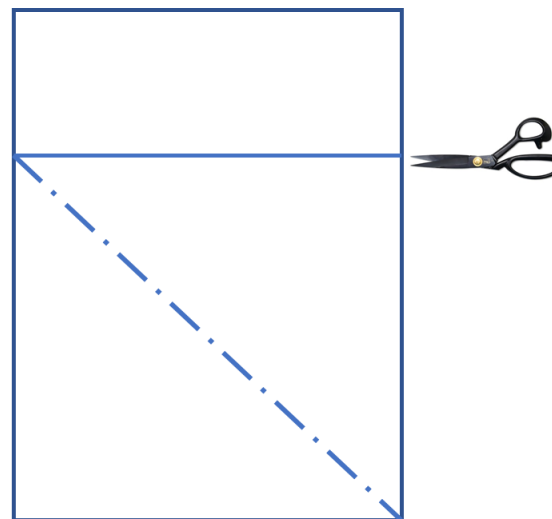

Cortar onde foi marcado, o vinco já marca a diagonal do quadrado

4

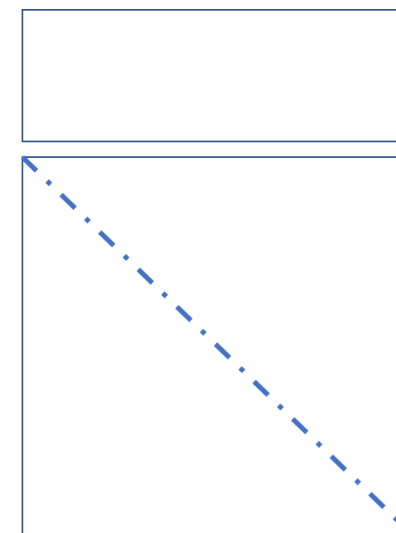

Cortar onde foi marcado e guardar a parte que tem o formato de um retângulo

Gradeamento do Quadrado

A partir de uma folha de papel, construa um quadrado.

5

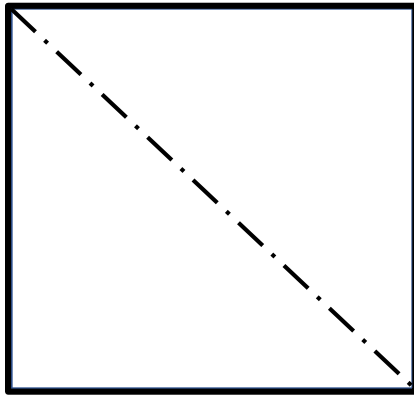

O quadrado

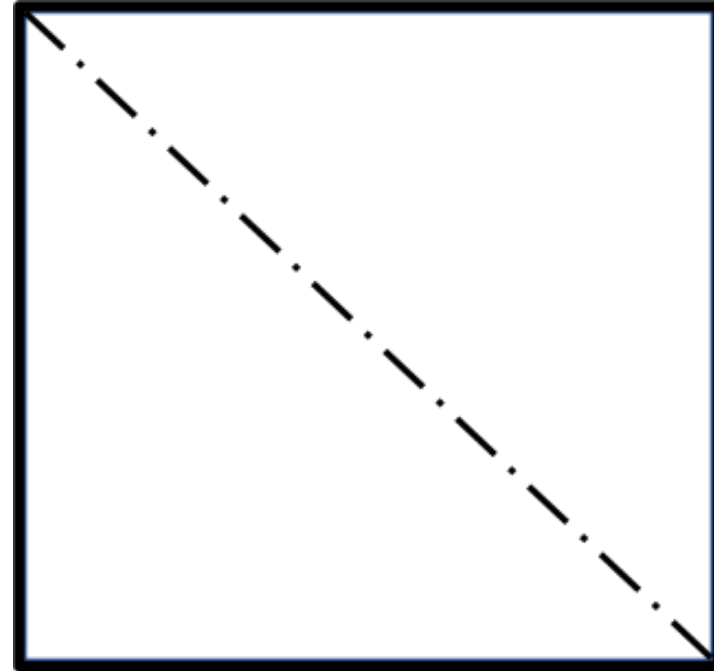

Temos uma diagonal a parti do vinco formado.

Gradeamento do Quadrado

Registrando as diagonais do quadrado.

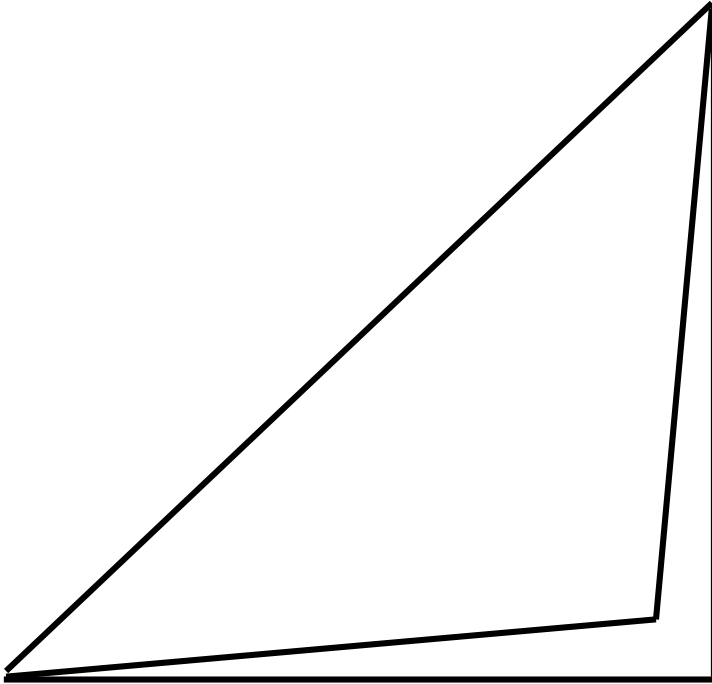

Para construir a segunda diagonal, basta unir os vértices da diagonal que já existe.

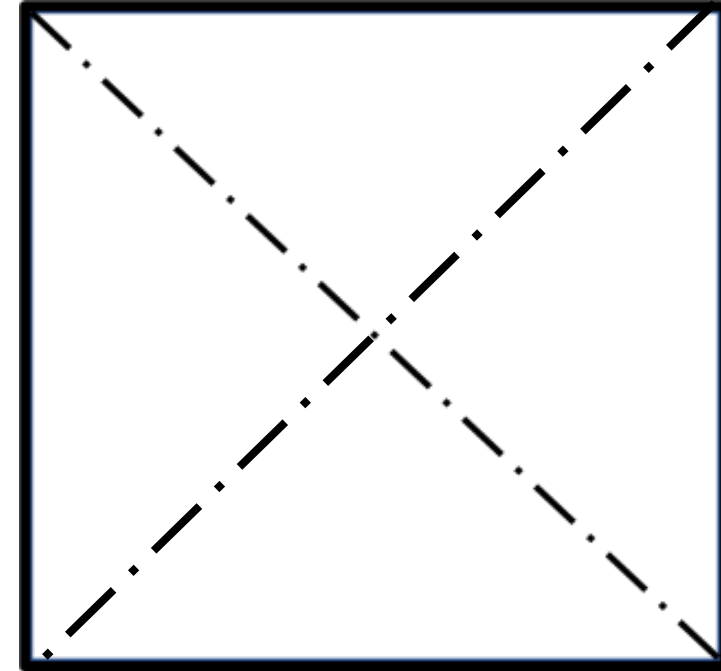

Os vincos formam as duas diagonais.

Gradeamento do Quadrado

Registrando as medianas do quadrado.

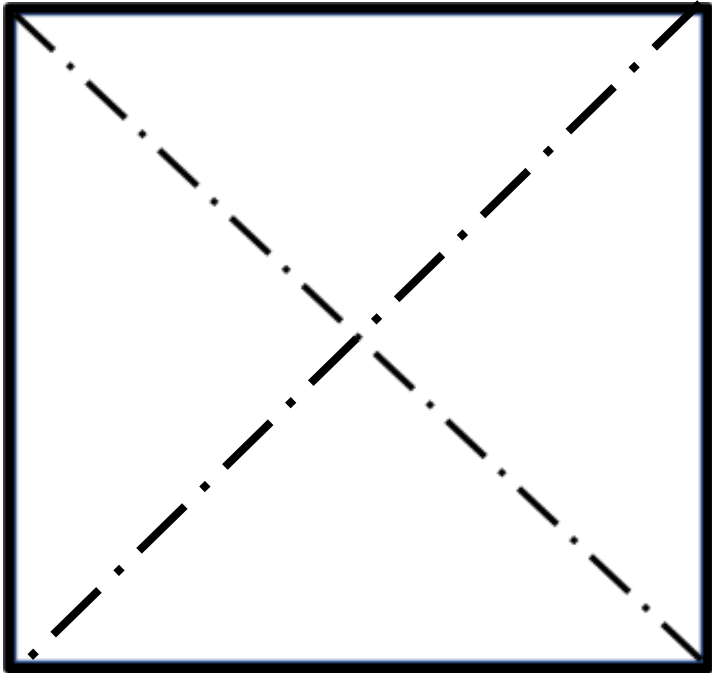

Para construir a MEDIANA, basta unir os lado esquerdo e direito do quadrado.

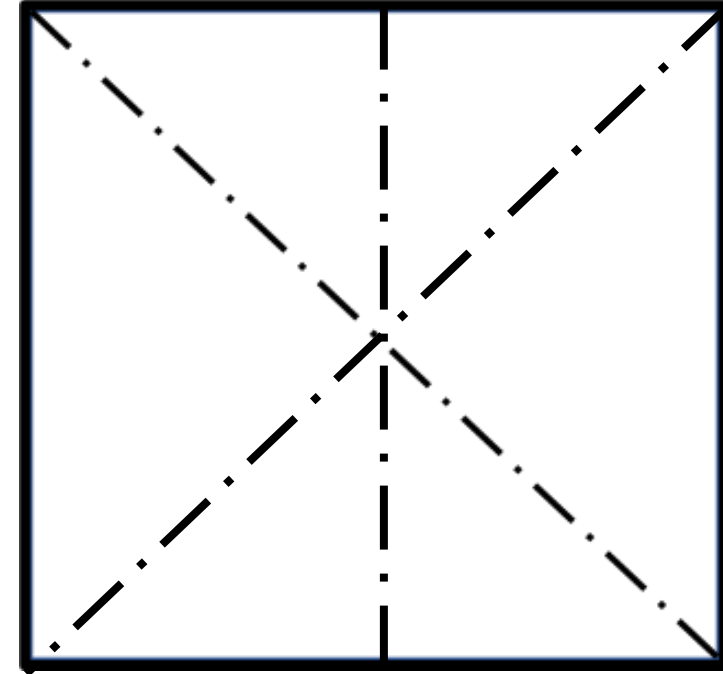
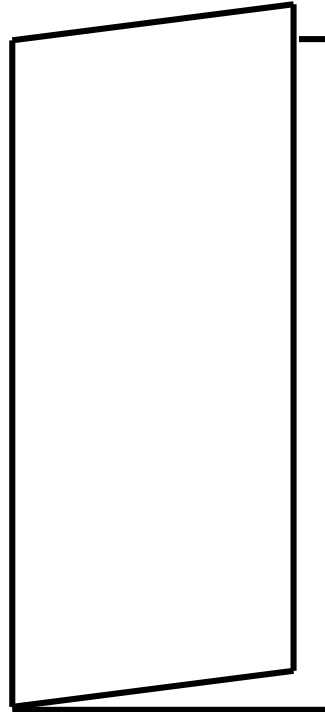

Os vincos formam as duas diagonais e mais a mediana vertical

Gradeamento do Quadrado

Registrando as medianas do quadrado.

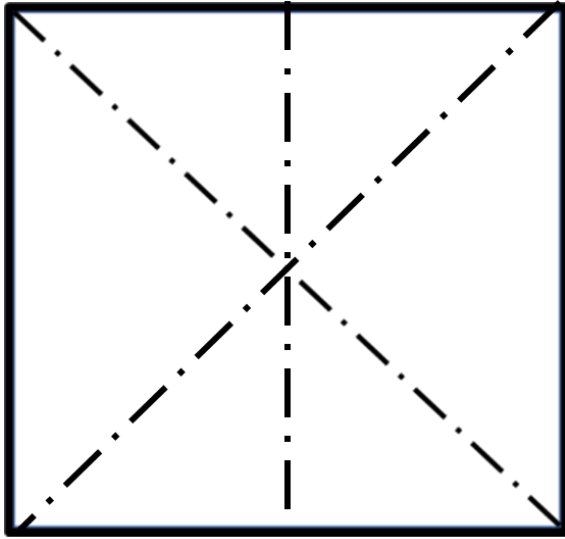

Para construir a segunda mediana, basta unir os lados superior e inferior do quadrado.

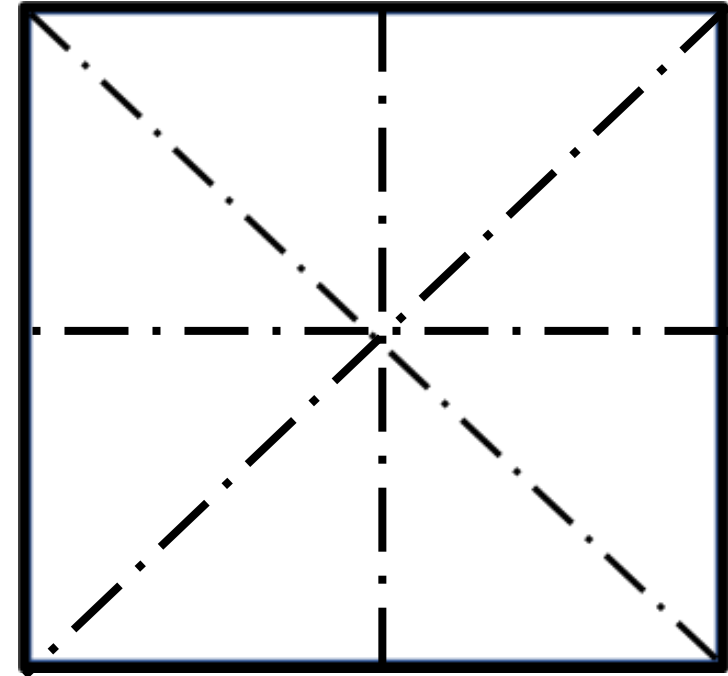

Os vincos formam as duas diagonais e duas medianas.

Gradeamento do Quadrado

Registrando outras medianas verticais.

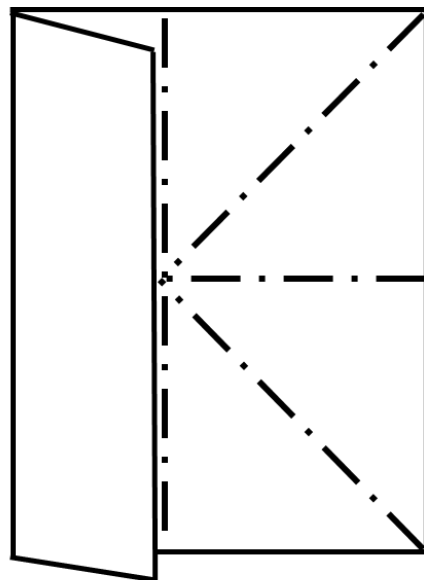
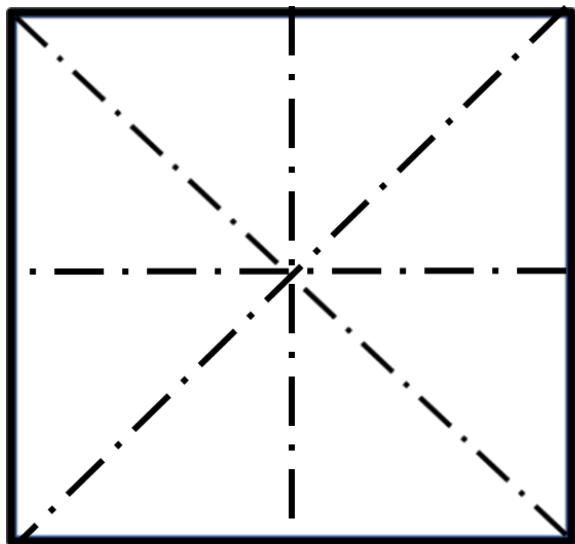

Coloque o lado sobre a mediana vertical.

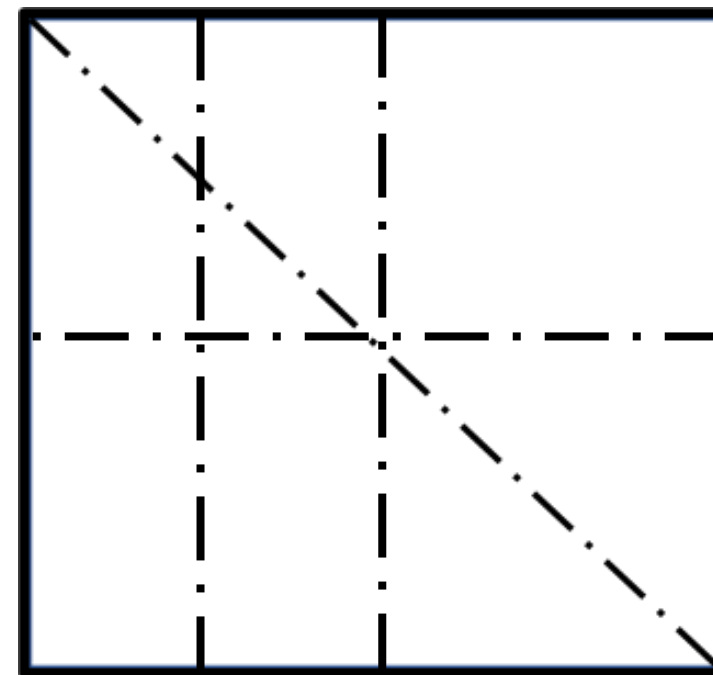

Surge uma linha vertical paralela à mediana

Gradeamento do Quadrado

Registrando outras medianas verticais.

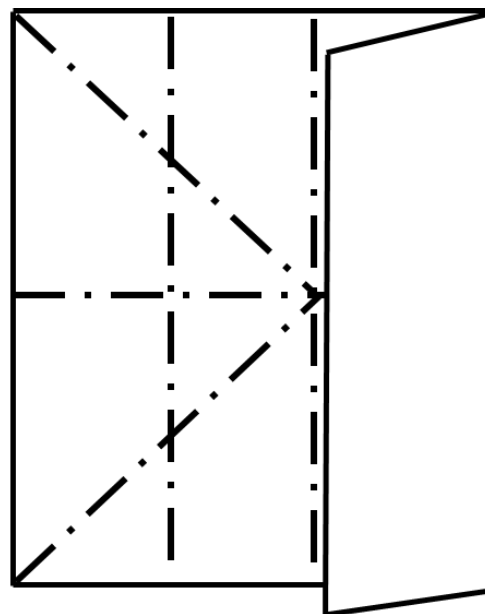
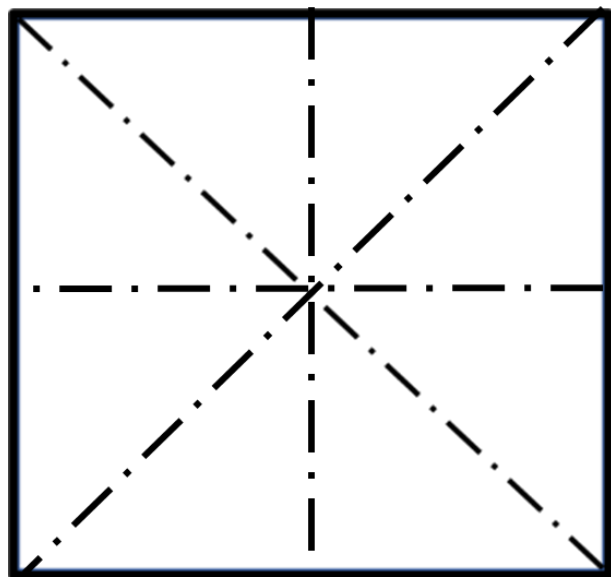

Repita o processo pela outro lado.

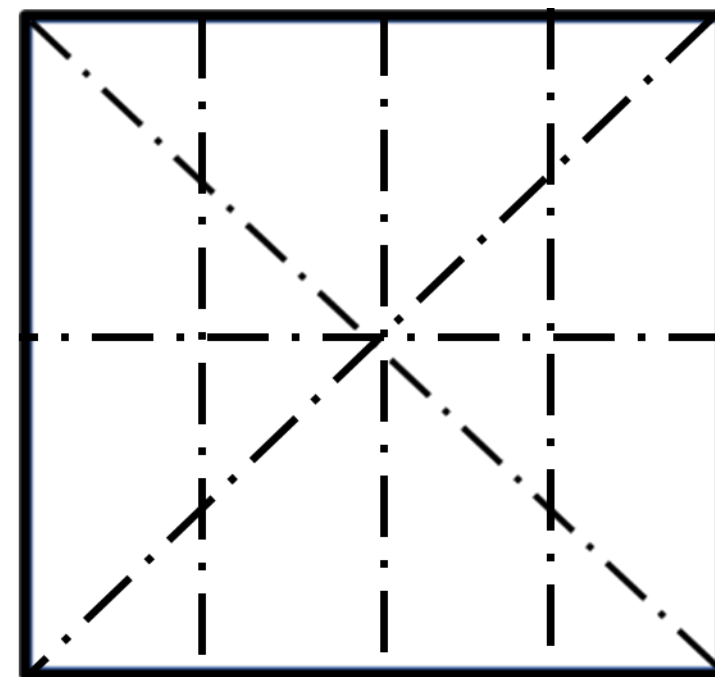

Surge outra linha vertical paralela à mediana

Gradeamento do Quadrado

Registrando outras medianas horizontais.

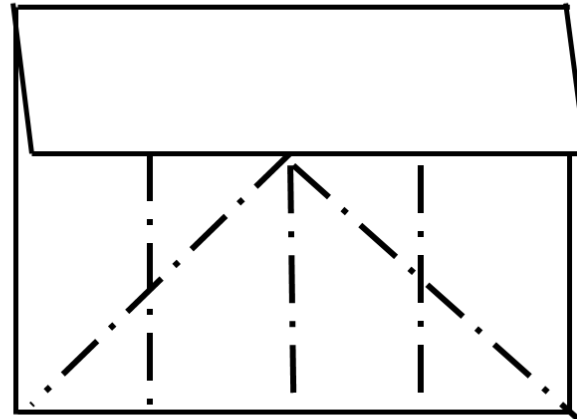
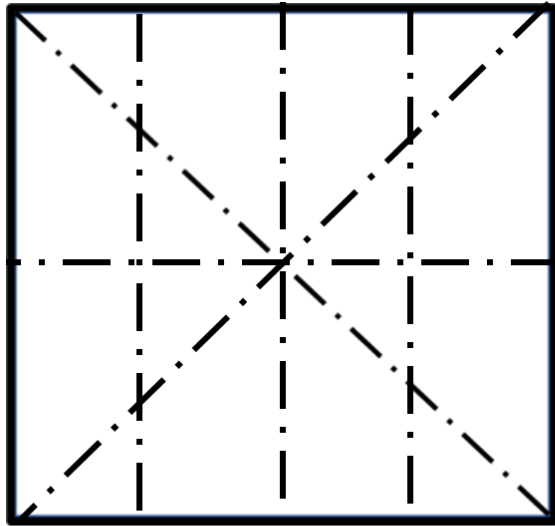

Vamos fazer a construção das linhas verticais, repetindo o processo.

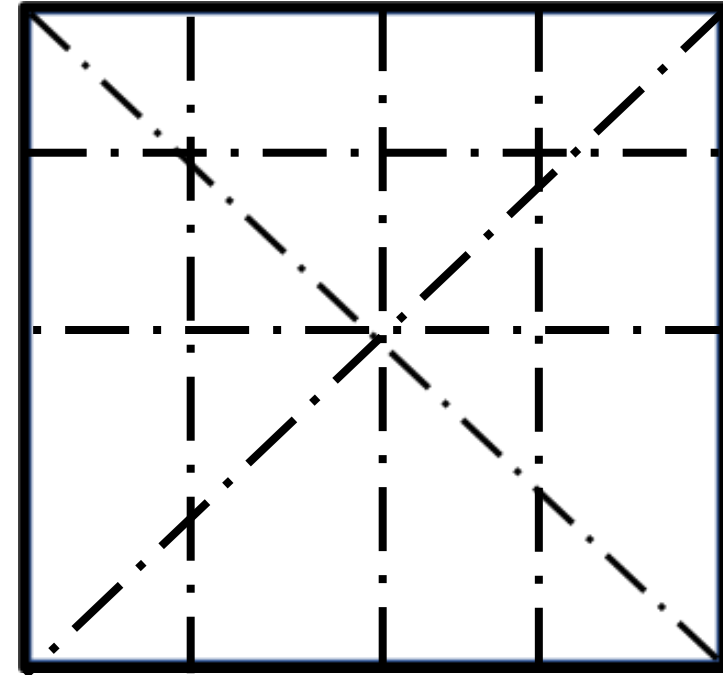

Os vincos verticais são construídos.

Gradeamento do Quadrado

Registrando outras medianas horizontais.

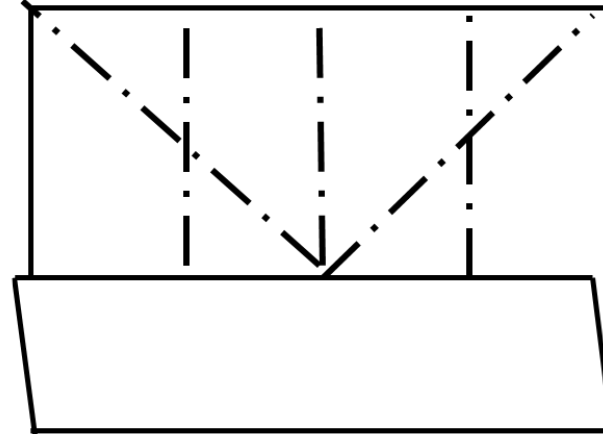
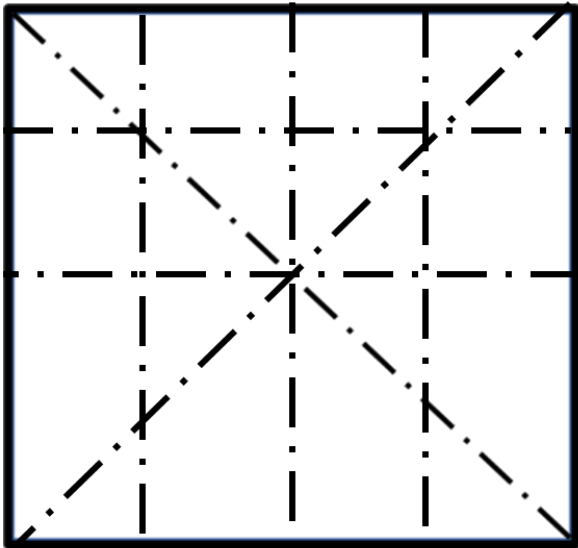

Repetindo o processo com o lado inferior.

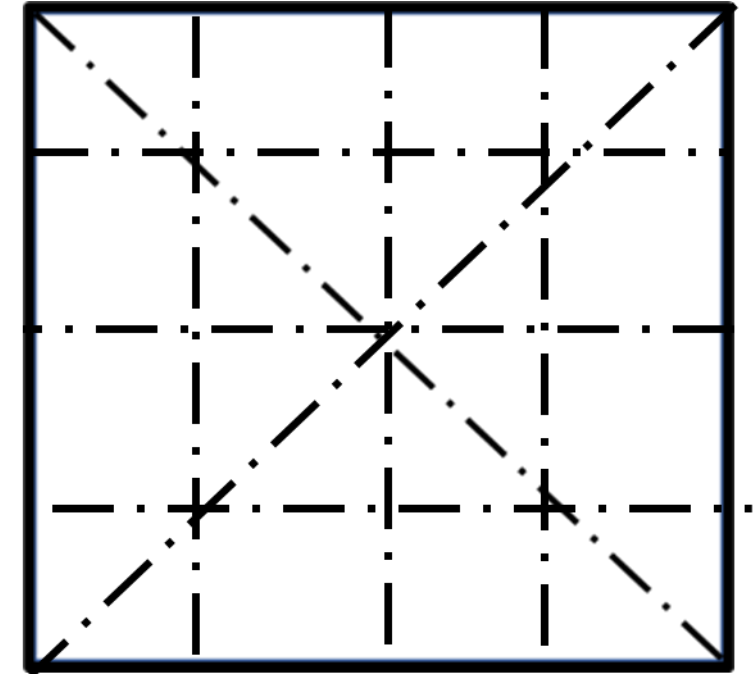

Agora temos a grade de vincos que divide o quadrado 16 partes iguais.